

YOUTH



LEVEL 2

BIBLE

LESSONS

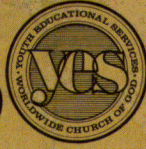

LESSON 10



Moses Is Called by God

MOSES IS CALLED BY GOD

After the death of Joseph and his brothers, their families continued to live in the land of Egypt. There they became known as **Israelites**.

After many years, a new Pharaoh became king of Egypt. He was very mean to the people of Israel. He was afraid of the many Israelites who lived in the part of Egypt called **Goshen**.

Pharaoh made slaves of the Israelites. He made them work very hard for harsh Egyptian **taskmasters**. Pharaoh did this to keep the Israelites from having more children. But the harder the Israelites worked, the more children they had.

Pharaoh then ordered the **midwives** to kill all the newborn baby boys. But the midwives did not obey Pharaoh. Instead, they chose to obey God and not kill them. God blessed the midwives for their obedience and gave them houses to live in.

The Israelites were very unhappy. Each day they would make bricks for Pharaoh's buildings. The taskmasters also made them work in the fields. In all that they did,

Parents: Explain the meaning of the **boldface** words. Discuss with your child how the Israelites came to be in the land of Egypt. Also discuss why Pharaoh made slaves of the Israelites.

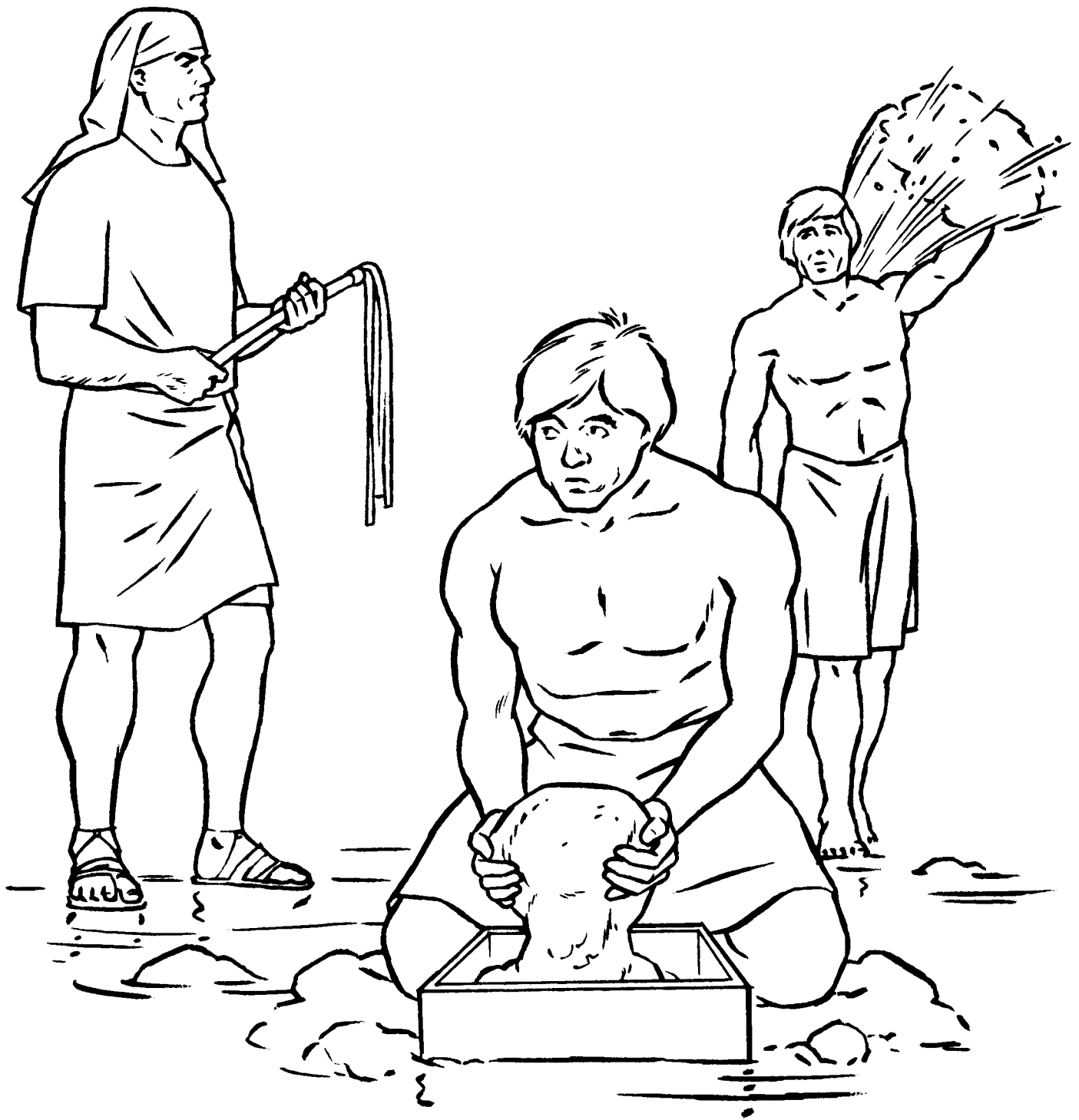

the Egyptians made them work very long and hard.

One day, an Israelite woman gave birth to a baby boy. He was a very handsome baby. His mother hid him where the Egyptian soldiers would not find him. She hid him for three months.



When she could no longer keep her son hidden, she made a small reed basket to put him in. After covering the basket with **pitch**, she carefully set it into the water at the river's edge. As the basket floated among the bulrushes, her daughter followed along to see what would happen.

The young girl soon saw Pharaoh's daughter pull the basket from the river. When Pharaoh's daughter opened the basket, she saw the baby boy inside. Quickly the



young girl ran to Pharaoh's daughter and asked, "Will you need someone to nurse the baby?"

"Yes, go and find an Israelite woman to nurse the child," replied Pharaoh's daughter. The young girl ran to tell her mother the good news. Now the mother could care for her own son before giving him back to Pharaoh's daughter.

Later, Pharaoh's daughter returned for the child. She took him back to Pharaoh's **court** where he would live. She named him Moses.



Moses became a prince in Pharaoh's court. He learned all about the Egyptians' **language** and customs. But Moses was very concerned about the Israelite slaves. One day he went to see them. On the way, Moses saw an Egyptian hitting one of the Israelites. Moses was angered. When he thought no one was looking, Moses killed the Egyptian and buried him in the sand nearby. But someone was watching.

When Pharaoh heard the news, he wanted to kill Moses. Moses had to quickly leave Egypt. He fled to the land of Midian where he became a shepherd for a man named Jethro. He later married Jethro's daughter, Zipporah.

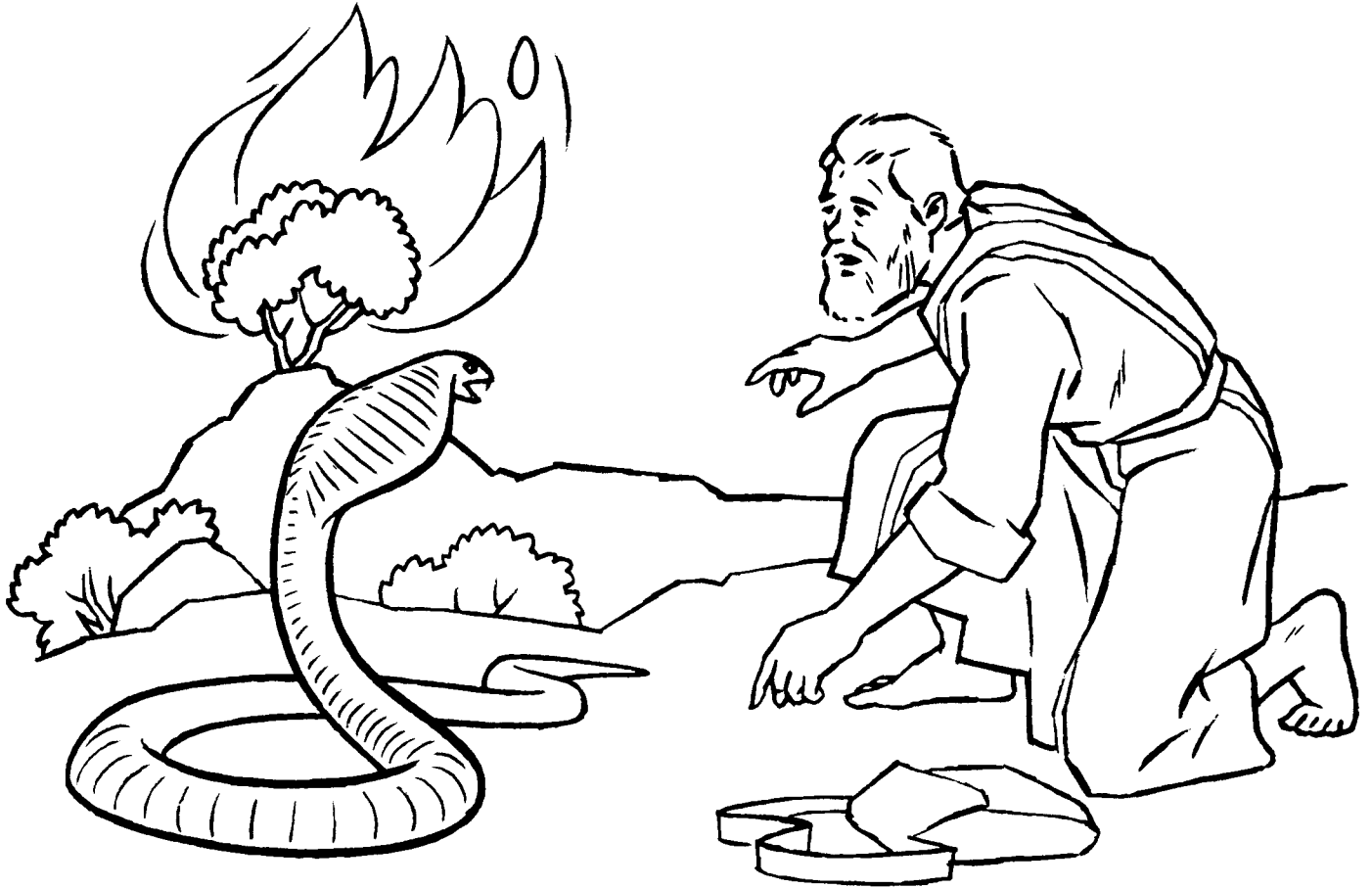

One day, while Moses tended his father-in-law's sheep near Mount Sinai, he noticed a nearby bush was on fire. As he went near, he was surprised to see that the bush was not being burned up. Then God spoke to Moses out of the burning bush. God told Moses to remove his shoes because the ground where he stood was **holy**.

"I have seen how the Egyptians have enslaved my people," God said. "I will send you to Pharaoh and you shall lead my people out of Egypt."

God also showed Moses a **miracle** that He would do before Pharaoh and the elders of Israel. "Cast your rod to the ground!" God commanded. As soon as the rod touched the ground it became a large, wiggling snake.

"Pick it up by the tail," God said. Moses slowly reached down and grabbed it by the tail. The snake became a rod in his hand.



Moses was afraid and told God that he could not speak well. So God agreed to let Moses' brother, Aaron, go with him and talk to Pharaoh.

God warned Moses that Pharaoh would not free the Israelites. God knew that He would have to perform great miracles and wonders before Pharaoh would let them go.

In our next lesson, we will learn what God did to free the Israelites.

CROSSWORD PUZZLE

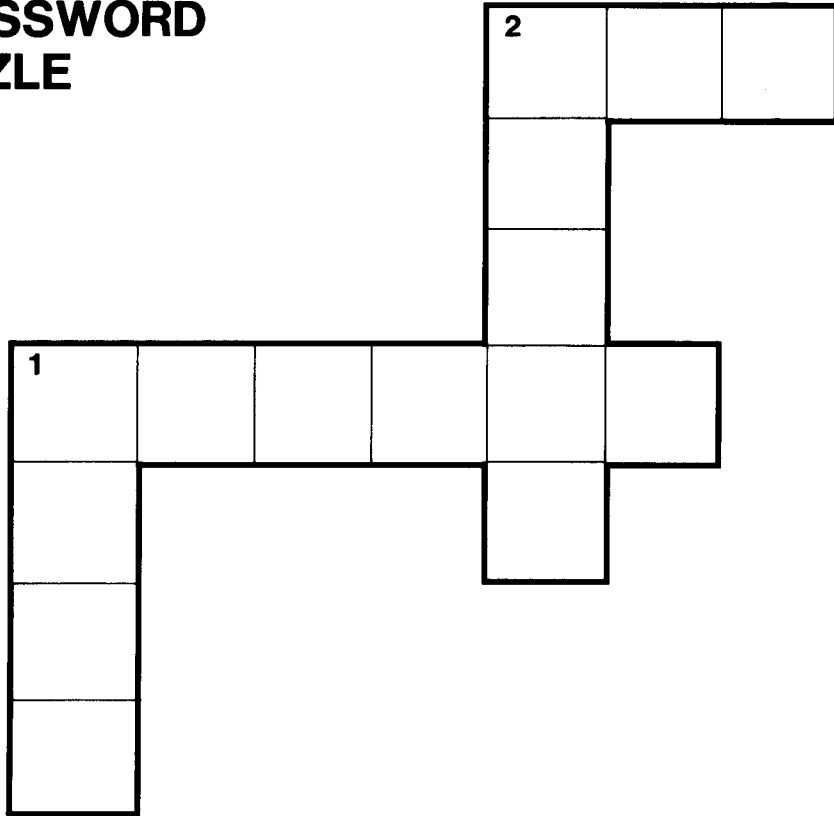

1. ACROSS

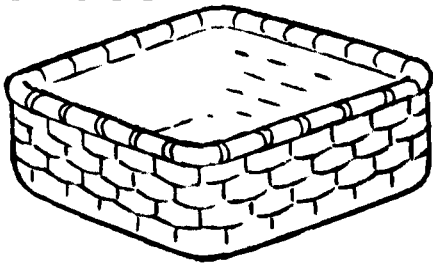

2. ACROSS

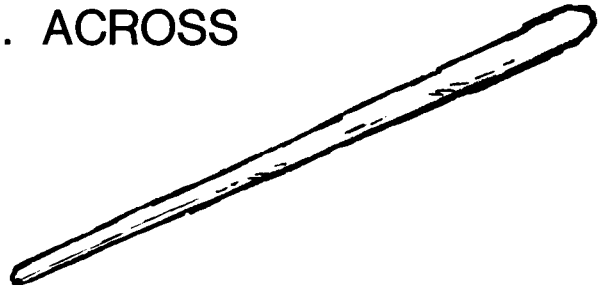

1. DOWN



2. DOWN

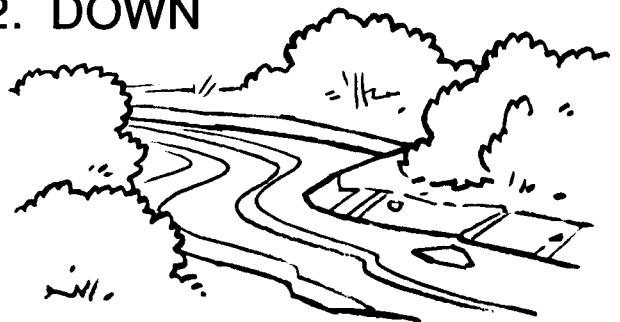

WORD SEARCH

Find each word from the Word Bank below in the Word Search puzzle. The letters may be read from left to right or right to left, from top to bottom or bottom to top or at an angle. Be sure to check off the words as you find them.

A R F A N I L B
Y I F O R O O B
W R R E B U F U
U A S C A O H L
A T M O S E S R
P R M D K I U U
T P Y G E A B S
Y I E P T E L H

WORD BANK

MOSES

AARON

BUSH

BASKET

BULRUSH

EGYPT

SCRAMBLED PUZZLE

Unscramble the letters and pictures to find words from this lesson.

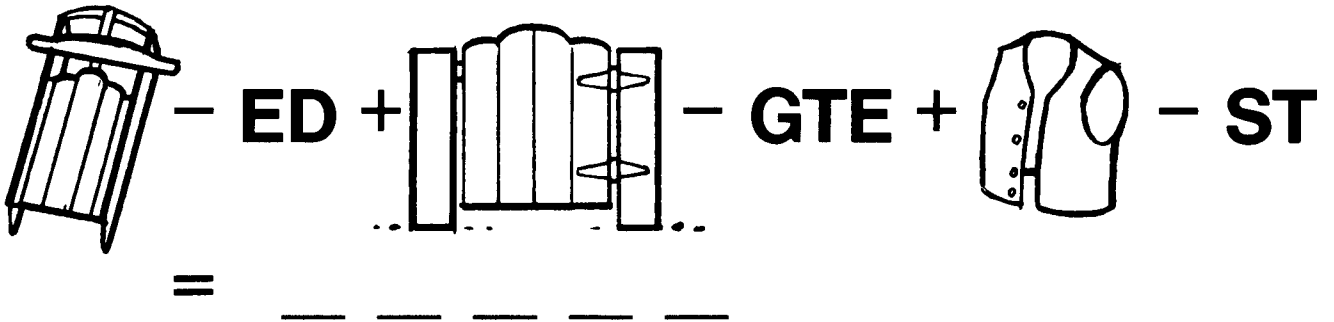
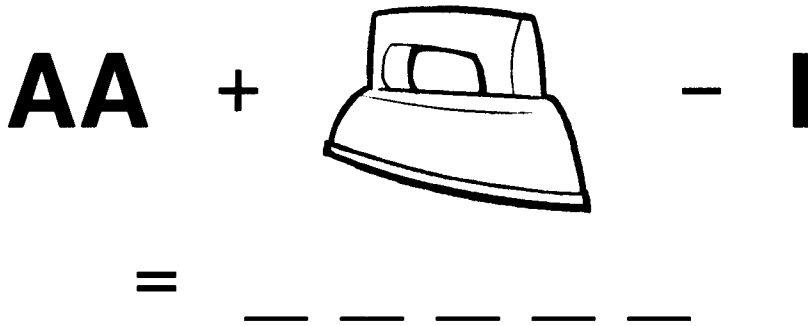
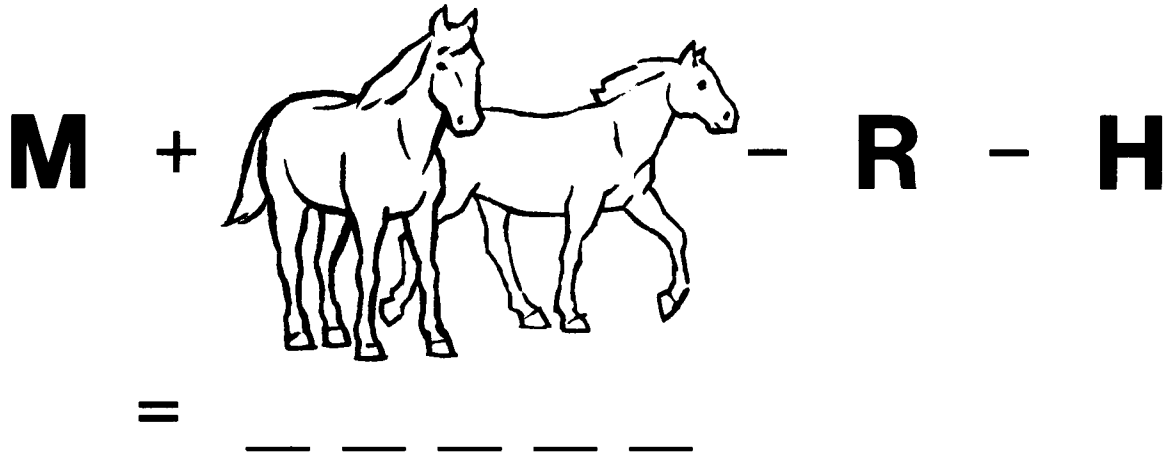

FOUNDER: HERBERT W. ARMSTRONG (1892-1986)

PASTOR GENERAL: JOSEPH W. TKACH

Published by the Worldwide Church of God and
produced in cooperation with Imperial Schools.

Copyright © 1986. All rights reserved.

BIBLE MEMORY

Psalm 23:1-6

ISRAEL IN EGYPT

Find out who our next lesson is about by drawing a line through the letters: X, Y and Z. Then write the rest of the letters on the lines below.

